

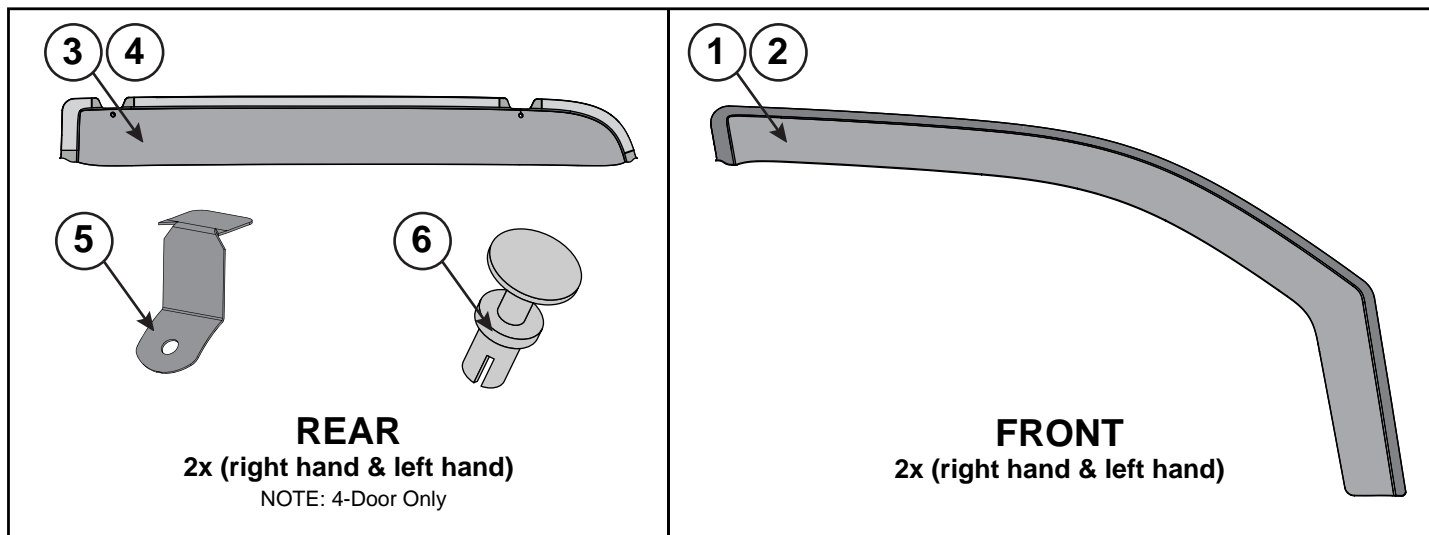

DODGE RAM SIDE DOOR WINDOW VISORS

www.mopar.com

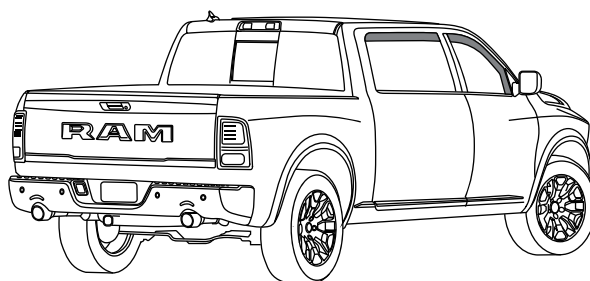

Call Out	Description	Quantity	Part Number
FRONT			82215478
1	Front RHS Window Visor	1	
2	Front LHS Window Visor	1	
REAR			
3	Rear RHS Window Visor	1	
4	Rear LHS Window Visor	1	
5	Rear Clip	4	
6	Rear Scrivet	4	

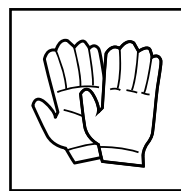
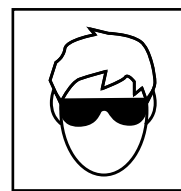
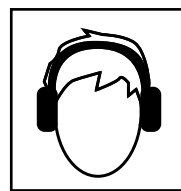

FRONT SET

1. Clean and dry the vehicle and lower the front and rear windows.

NOTE:

Ensure all surfaces are completely dry.

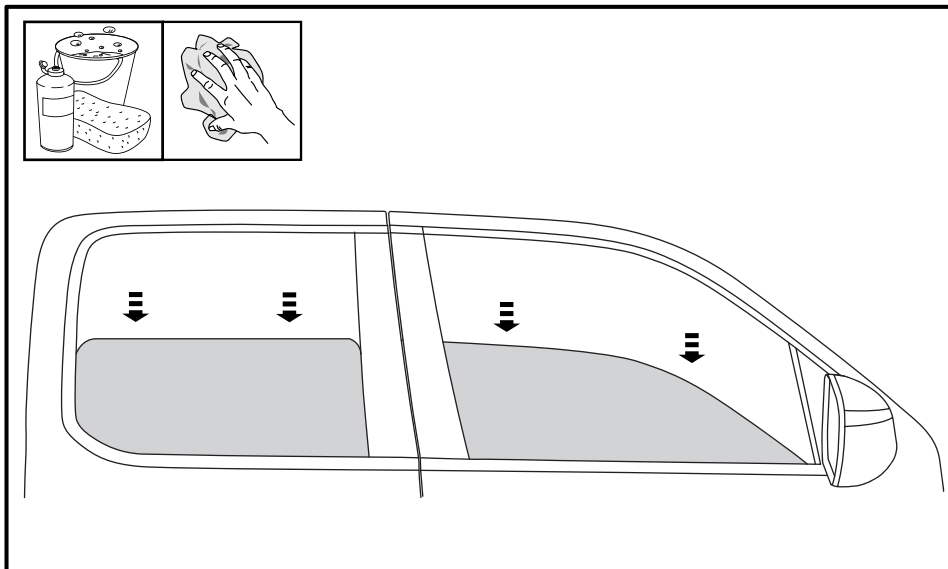

2. Fit the Visor (1) behind the mirror. Ensure the bottom edge locates on top of the lower window molding.

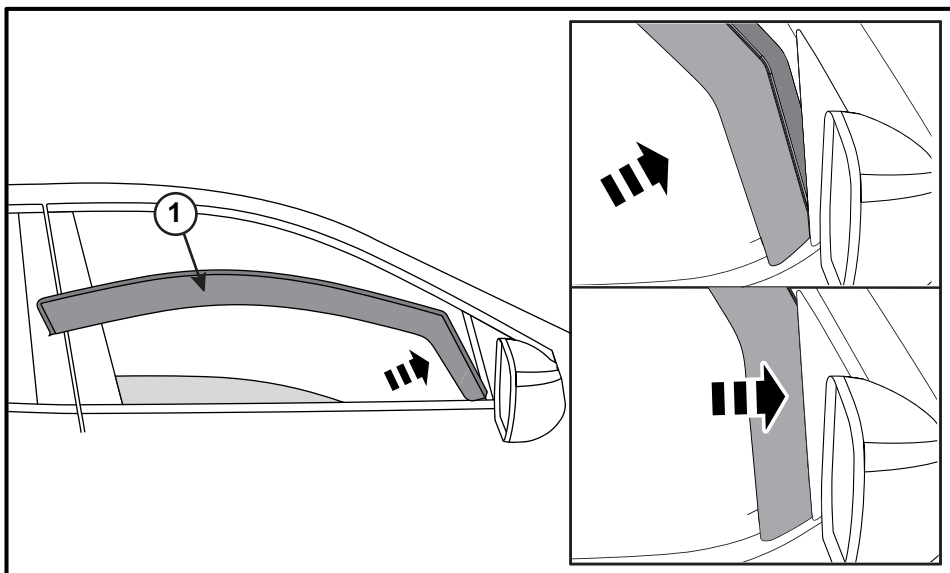

3. Fit the rear section into the door glass seal about 1/2 inch away from the top of door frame.

IMPORTANT:

When fitting it is necessary to bend the center away from the vehicle to enable fitment.

Take care not to break the Visor. (Safety glasses must be worn)

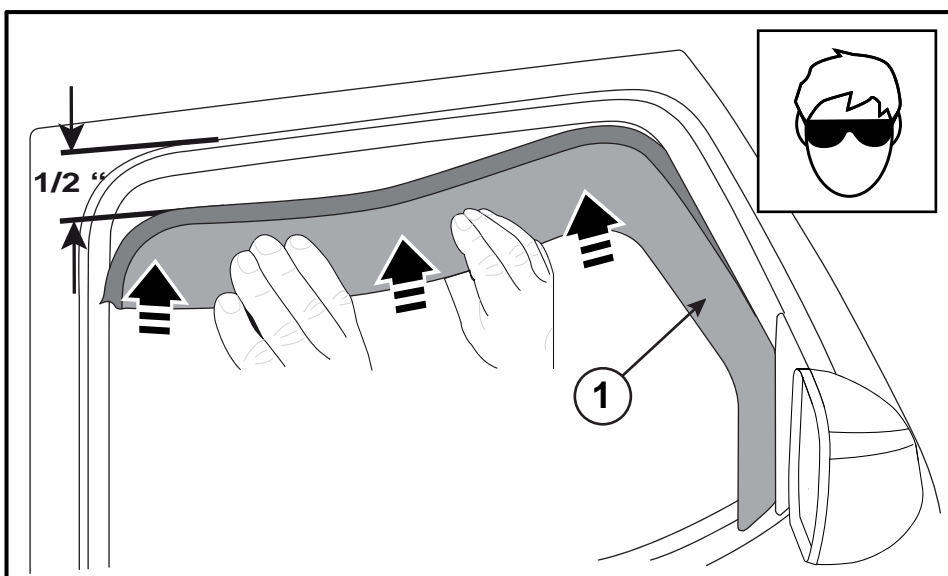

4. Start inserting the Visor (1) by carefully rotating it into the door glass seal.

Once installed gently push the Window Visor upwards.

IMPORTANT:

Work from the front to the back.

Check the weather strip end and ensure that it is not twisted or rolled over along with the air deflector.

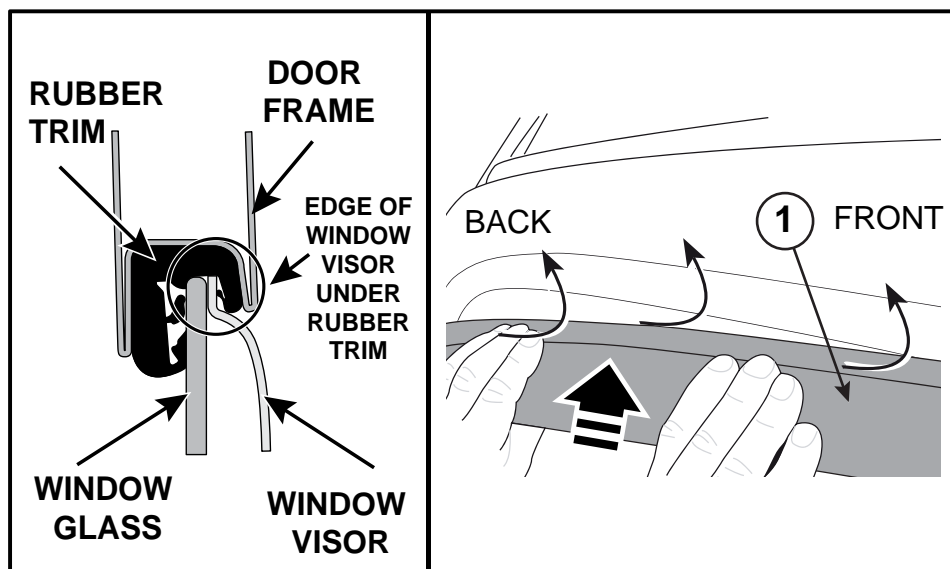

5. Ensure the Visor (1) is located in the outermost section of the door glass seal.

Pull the bottom of the visor outward while raising and lowering the window a minimum of 5 times.

Repeat steps 1-5 for Visor (2).

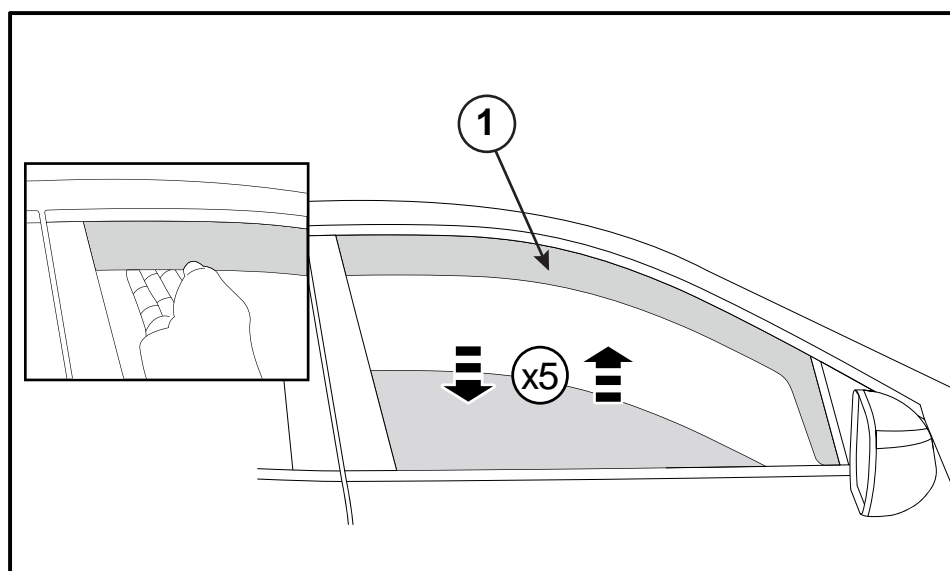

AFTER INSTALLATION WINDOWS SHOULD REMAIN FULLY CLOSED FOR 24 HOURS FOR BEST RESULTS



24 HOURS

REAR SET - 4 DOOR ONLY

1. Trial fit the Visor (3) onto the rear door frame.

Align it in position and note and mark where the two slots correspond to the door.

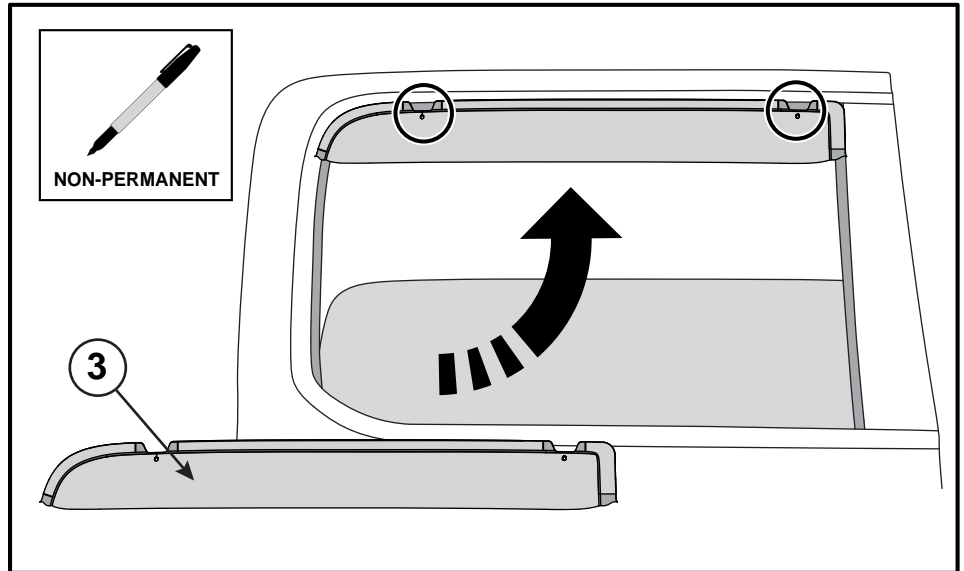

2. Pull the glass seal away from the door frame and install the clips into the seal at the noted locations.

Re-install the seal and clips back into the door frame.

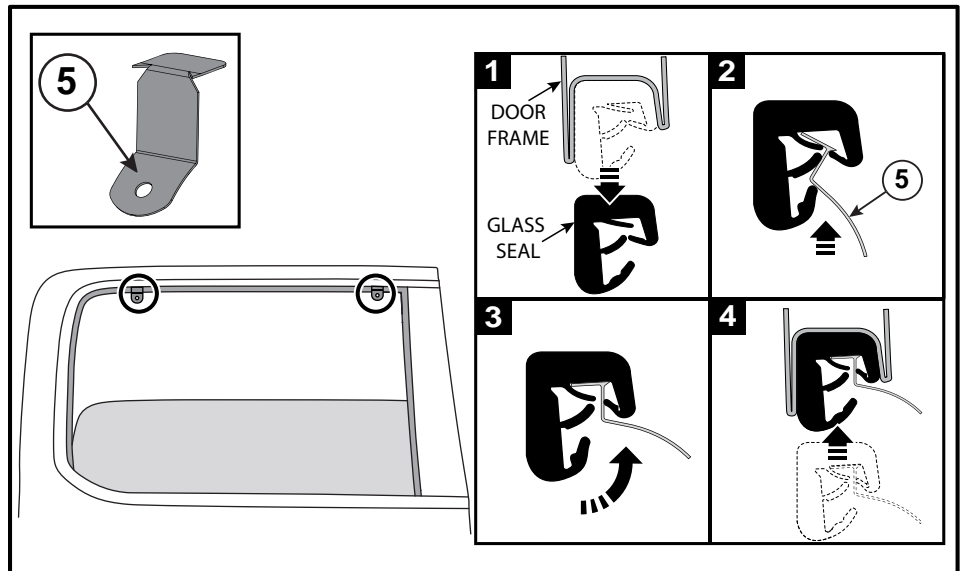

3. Peel back 50mm of the centre tape lining and fold down.

Fully remove and discard the tape lining at each end.

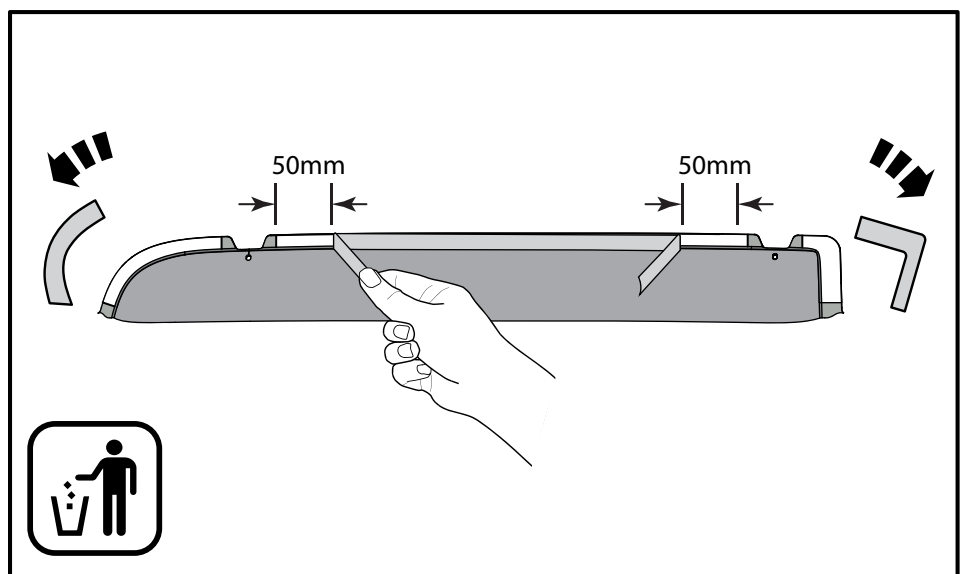

4. Angle the clips downward, align the cutouts with the clips and slide the Visor (3) into the door glass seal in front of the clip.

Push the clip and visor firmly up into the window channel and against the inside face of the door glass seal to ensure full tape adhesion.

NOTE:

Take care not to touch the tape.

Check the weather strip end and ensure that it is not twisted or rolled over along with the air deflector.

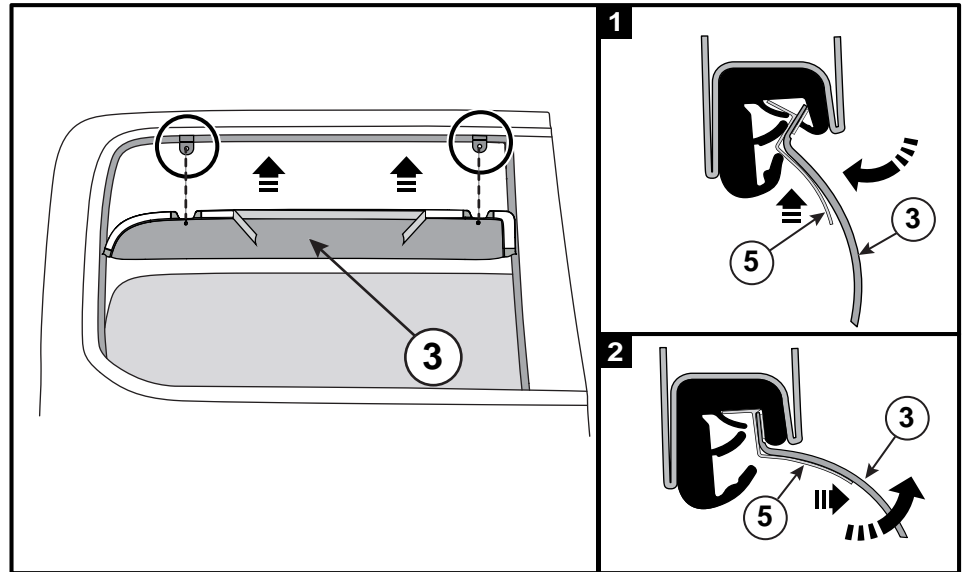

5. Install the push rivets (6) through the slots and secure them to each clip.

Slowly pull the tape lining away and discard.

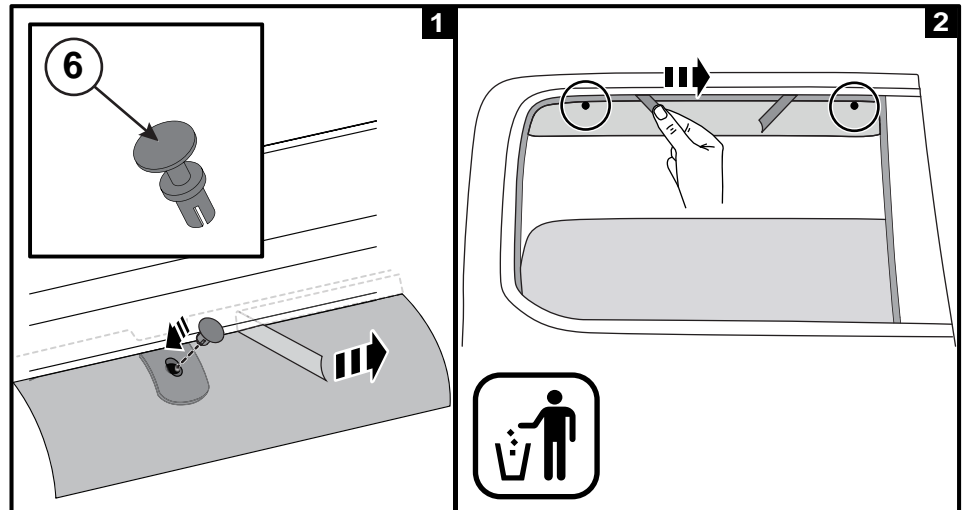

6. Pull the bottom outwards while raising and lowering the window a minimum of 5 times.

Repeat steps 1-6 for Visor (4).

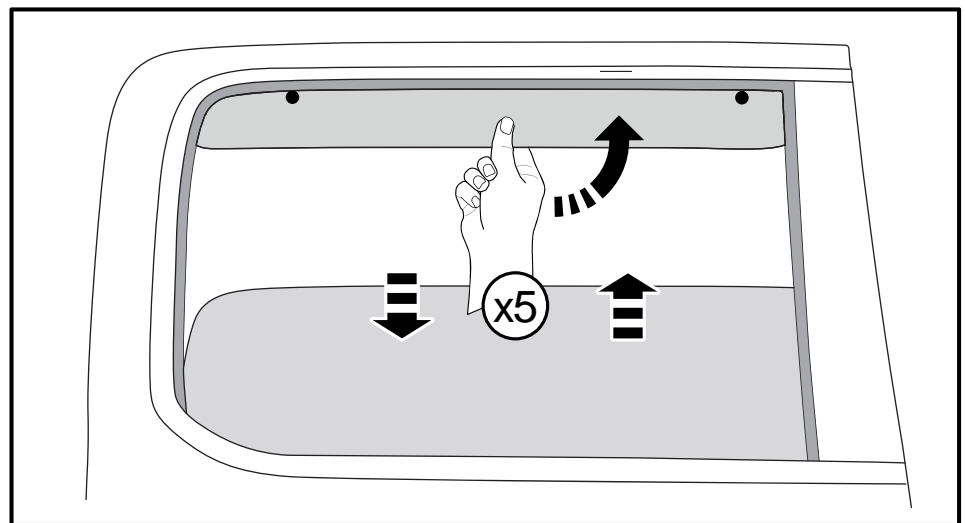

AFTER INSTALLATION WINDOWS SHOULD REMAIN FULLY CLOSED FOR 24 HOURS FOR BEST RESULTS



24 HOURS